



STEP 1 – PRIOR TO INSTALLATION

- A) Bushwacker only approves installing the flares according to these written instructions with the hardware provided. WARNING:** Failure to install according to these instructions will invalidate the warranty. This includes, but is not limited to using alternative installation methods, hardware, or materials. **DO NOT USE:** Loctite, SuperGlue, or similar products on the hardware or the flares.
- B) Fit:** Verify the fit of the flares to vehicle. (Some filing, sanding, or cutting may be necessary to ensure proper fit).
- C) Painting:** (Optional) if paint is desired it must be done prior to installing flares on vehicle. Clean outer surface with a good grade degreaser. **DO NOT USE LACQUER THINNER OR ENAMEL REDUCER AS A DEGREASER.** Wipe outer surface thoroughly with a tack rag prior to paint. Application of plastic adhesion promoter for ABS plastic as per your paint system manufacturer's recommendations is required. Paint flares using a high quality enamel, or polyurethane automotive paint. If painting edge trim (not recommended), use a flex additive.
- D) Performance:** Using larger Tires may increase the area required to turn the vehicle. Some Tire/Rim combinations may require lowering bump stops and or installing steering stops to prevent tire from contacting flare.
- E) Exhaust System:** Modifications may be necessary to maintain a minimum 4" clearance between flares and exhaust pipes. (Exhaust gases should not vent directly onto flares)
- F) Metal Protection:** All exposed fasteners and bare metal should be treated with rust resistant paint BEFORE installing flares. Spray inner fender wells with undercoating AFTER flare attachments have been completed.
- G) Decals:** Flares may interfere with existing decals on vehicle. If you wish, remove decals prior to installation of flares.
- H) Care & Cleaning:** Bushwacker fender flares are built to last; any detergent you use to wash your vehicle is sufficient to clean the flare. Do not use any harsh abrasive detergents.

Jeep® Cut-Out™ Fender Flares Set of 4

Set Part #10909-07

Rev-10 1/11/2016

For complete fitment info visit : www.bushwacker.com

TOOLS FOR EASY INSTALLATION:





- Drill
- 3/16" Drill Bit
- #2 Phillips Bit
- 5/16" Wrench
- 5/16" Socket
- 7/16" Wrench
- 7/16" Socket
- Socket Driver
- Scissors
- T45 Torx Bit

PLEASE READ: Dirt and debris can become lodged between the fender flares and the vehicle's fenders, causing scratching and paint wear from vibration. Lund International is not responsible for any damage, and the installation of our fender flares is done with the buyer's understanding that this scratching and paint wear may occur.

LIMITED LIFETIME WARRANTY AGAINST ANY MANUFACTURING DEFECTS

- To claim a warranty, you must provide Proof of Purchase.

Included in Hardware Kit:

- | | | | | | | | | | |
|----|---|----|---|----|---|----|---|----|---|
| 1. |  | 2. |  | 3. |  | 4. |  | 5. |  |
| | GP1-0008,
Duro (NC02/S 70)
Edge Trim,
240 inches | | SP1-0011,
1/4" x 5/8" x .187"
Neo Black Spacer,
40 pcs | | SW1-0016,
8 x 1-1/2"
Phillips Screw,
4 pcs | | SW1-0045,
#14-14 x 1"
Torx Screw,
28 pcs | | SW1-0052,
T-45 Torx Bit,
1 pc |

Flare Installation Procedures:

STEP 2 - Prepping Installation Area (Front & Rear):

- A) Remove the factory fender flares and stone guards.
- B) Remove the marker light from the front fender flare.
- C) Remove Fender Flares from box and lay flat to allow them to return to their natural position. Preferable temperature is 75 degrees F or warmer.

STEP 3 - Edge Trim Installation: Figure #1

- A) Peel two to three inches of red vinyl backing away from edge trim tape. Applying the adhesive side of the edge trim to the inner side of the flare, affix the edge trim to the top edge of the flare (the portion that comes in contact with the vehicle).
- B) Press edge trim into place along the top edge of the flare in one-foot increments, pulling red vinyl backing free as you continue to work your way around the top edge of the flare. Repeat steps 3A and 3B for remaining flares.
- C) Trim excess edge trim away with scissors.

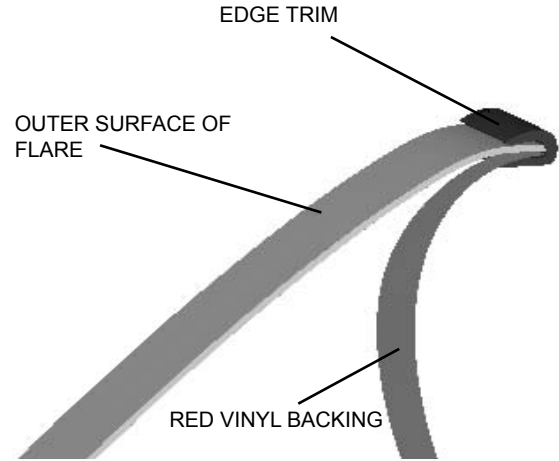

Figure #1

STEP 4 - Trimming Fenders (For tires over 33"):

- A) Mark a point on the front fender 4 3/4" forward from the vertical seam at the rear of the fender. See Figure #3
- B) Draw a line from that point to a point tangent to the wheel opening, and cut along that line with an air nibbler or reciprocating saw. See Figure #3
- C) Draw two lines on the rear fender tangent to the wheel opening and through the lower holes at the front and rear of the fender. See Figure #2
- D) Cut the rear fender along those lines using an air nibbler or a reciprocating saw. See Figure #2

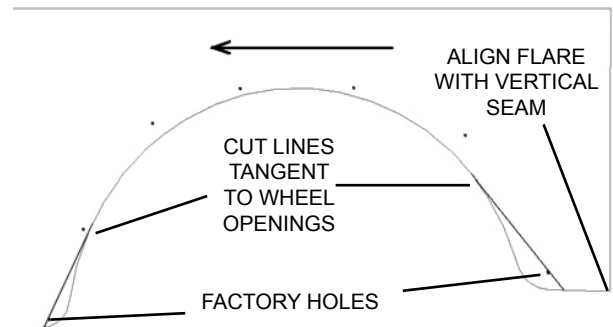

Figure #2

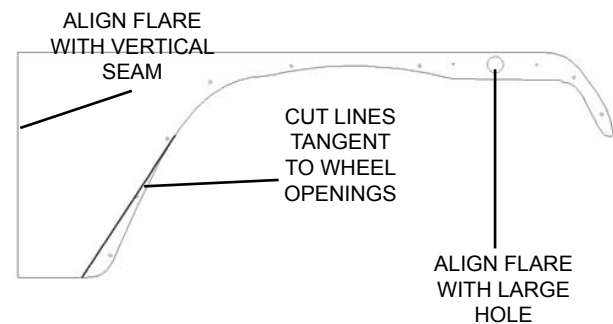

Figure #3

STEP 4 - Trimming Fenders (For tires over 33"):

STONE GUARD:

- A) Fasten the stone guard to the vehicle with the factory screws that were previously removed. Some modification may need to be made for a proper fit.

FRONT FLARE:

- B) Holding the front flare in place on the vehicle, align the 1¼" hole in the marker light pocket with the large hole in the fender and mark the mounting hole locations on the vehicle fender using the holes in the flare as a guide.
- C) Drill the vehicle fender at all marked positions with a 3/16" drill bit.
- D) For the Front Flare, insert a supplied Torx screw through hole in pocket. Place two 1/4" thick spacers on the screw from the back side of the pocket. **See Figure #4.**
- E) Holding the flare into position on the fender, insert the screws through the drilled holes in the fender. Use caution: Do not over tighten the screws. Over tightening will not allow the flare to expand and contract with temperature changes after the flare is installed.
- F) Install the marker light into the flare and reattach the marker light to the factory holes that it came out of, using the 1½" screws in the hardware kit.

REAR FLARE:

- G) Holding the rear flare in place on the vehicle, align the rear corner of the flare with the vertical seam at the rear of the vehicle and mark the mounting hole locations on the vehicle fender using the holes in the flare as a guide.
- H) Remove the flare.
- I) Drill the vehicle fender at all marked positions with a 3/16" drill bit.
- J) For the Rear Flare, insert a supplied Torx screw through hole in pocket. Place one 1/4" thick spacer on the screw from the back side of the pocket. **See Figure #4.**
- K) Holding the flare into position on the fender, insert the screws through the drilled holes in the fender. Use caution: Do not over tighten the screws. Over tightening will not allow the flare to expand and contract with temperature changes after the flare is installed.

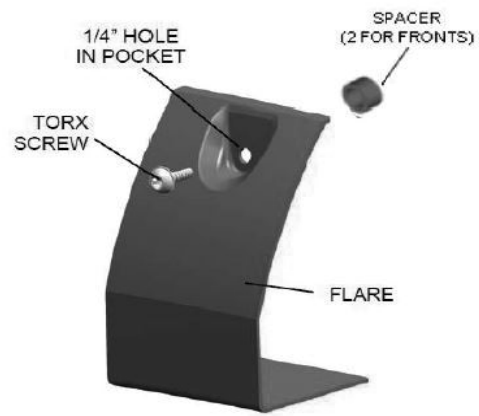

Figure #4



Figure #5