









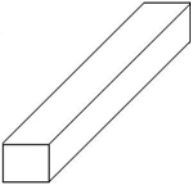

Installation Support

Monday - Friday
7am - 4pm PST
800-345-8476

Instruction / Parts Guide 57-7100 thru 57-7125 Models

This installation should be performed by two people.

Item/Part	Qty	Description
	2	2" x 2" x 25" Aluminum Support Leg
	6	5/16" x 1 1/4" Hex Cap Bolt
	2	1/4" Fender Washer
	2	1/4" Lock Washer
	2	1/4" Hex Nut
	2	1/4" 20 x 3" J Bolt
	6	5/16" Nylock Nut
	12	5/16" Flat Washer

DWG 1

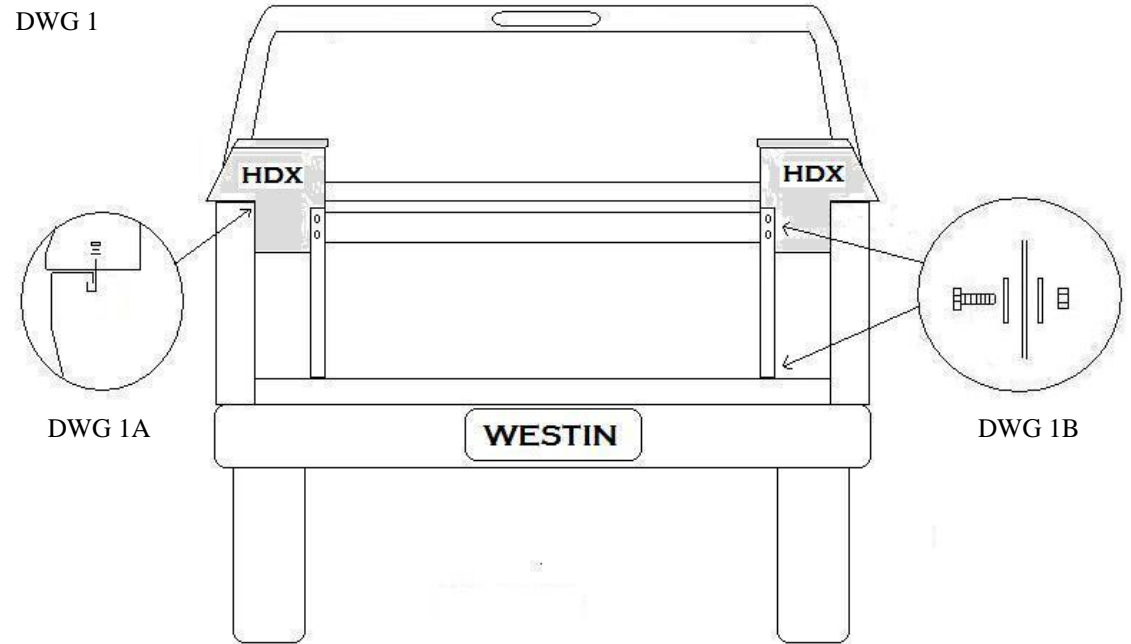

DWG 1A

DWG 1B

Step 1: Lay rail protection down then balance tool box on bed rail using a support in the bed to steady the box while you are working. Have your helper also hold the box to keep it from rocking.

Step 2: Open door, be sure your helper is holding the box so it doesn't fall off when unbalanced.

Step 3: On the underside of the tool box and close to the bed rail (rear of truck), drill a 5/16" hole to accept the "J" bolt. Push the "J" bolt thread up into the hole while hooking the bed rail lip. Your helper can then secure it with a fender washer, lock washer and 5/16" hex nut. See DWG 1A. Repeat at the front of the bed rail.

Step 4: Be sure the box is level and install one 2" x 2" x 25" aluminum leg support at the back corner of the box. See DWG 1. Mark where to drill through the holes in the top of the leg, drill two 3/8" holes through the box then secure with a 5/16" x 1 1/2" hex bolt and flat washer, tighten on the inside of the box using a 5/16" flat washer and Nylock nut. See DWG 1B. Repeat at the front of the truck.

Step 5: Drill 3/8" hole through the foot of the support leg and through the floor of the truck bed. Before drilling get under the vehicle to be sure no wires or dangerous obstructions are near the area to be drilled. Secure the foot by inserting a 5/16" x 1 1/4" hex bolt and flat washer then from under the vehicle install another 5/16" flat washer and secure with a 5/16" Nylock nut. Secure all fasteners and the installation is complete.