



**B&W Trailer Hitches**  
 1216 Hawaii Road / PO Box 186  
 Humboldt, KS 66748  
 800.248.6564  
 620.473.3664  
 Fax:620.473.3766

**NOTE: *We recommend reading instructions before beginning the installation.***  
**WARNING: *The tow vehicle's towing capacities should under NO circumstances be exceeded.***

# Turnoverball™ Gooseneck Hitch Installation Instructions

## Model 1104R

Call or Email us for Installation Support

hitches@turnoverball.com  
 www.turnoverball.com

**2004-2014 Ford 1/2 Ton Trucks All Beds**  
*(2004 HERITAGE REQUIRES MODEL # 1197R)*

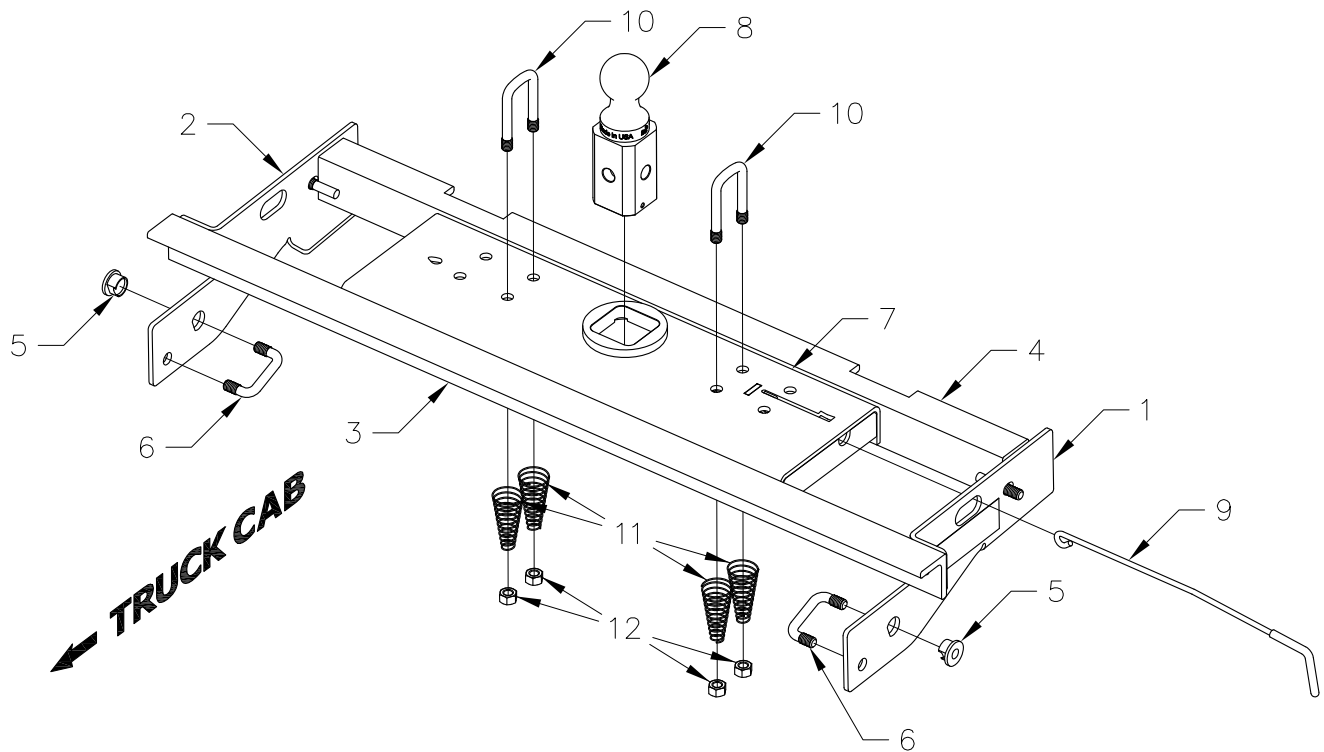

Mounting Kit Box (GNRM1104)		
ITEM	DESCRIPTION	QTY
1	Driver Side Plate	1
2	Passenger Side plate	1
3	Front Crossmember	1
4	Rear Crossmember	1

Center Box (GNRC959N)		
ITEM	DESCRIPTION	QTY
7	Center Section	1
8	2-5/16" Ball	1
9	Latch pin Handle	1

Mounting Kit Bolt Bag		
5	Sideplate Insert	2
6	2" X 1-1/4 X 1/2" U-Bolt	2
	1/2" Cap Screw	9
	1/2" Lock Washer	15
	1/2" Flat Washer	13
	1/2" Finish Nut	15

Safety Chain Kit Bolt Bag		
10	1/2" U-Bolt	2
11	Conical Springs	4
12	1/2" Lock Nut	4
	5/16" X 3/4" Carriage Bolt	1
	5/16" X 3/4" Cap Screw	1
	5/16" Lock Nut	1

**NOTICE:** This product was designed to fit vehicles in their original, "as manufactured" condition. Compatibility with vehicles having replacement parts, or other modifications is not guaranteed. Inspect vehicle for modifications before installation of this product.

# BEFORE INSTALLING

## OVERHEAD LIFTING DEVICE

An overhead-lifting device, such as chain falls, engine hoist, or cable come-a-long, can be used to lift the center section of the hitch in place. Lower a loop of rope or chain through the 4" hole in the truck bed floor and attach it to the latch pin in the round hitch receiver tube in the center section. Use the lifting device to raise the center section until the round hitch receiver tube that protrudes from the center section fits in the 4" hole in the truck bed floor. Maintaining upward pressure may facilitate fastening the crossmember to the center section, especially if the truck bed floor has been distorted downward from heavy use. If you use an overhead-lifting device, it should be disconnected before squaring the center section across the frame, installing the sideplates and torquing fasteners.

## WARNING

Most trucks have FUEL LINES and/or BRAKE LINES and/or ELECTRICAL WIRES located along the frame rails where B&W Turnoverball™ hitches install. Carefully examine the location of fuel lines, brake lines and electrical wires BEFORE INSTALLATION. Be certain you will not damage fuel lines, brake lines or electrical wires when positioning hitch components, drilling holes and tightening fasteners. The fuel tank vent, located on top of the gas tank, can be easily damaged during the installation of the hitch components. Care must be taken when positioning the front crossmember and center section components.

## WARNING

*ON SHORT BED TRUCKS, BEFORE INSTALLING THIS HITCH, CHECK FOR ADEQUATE TURNING CLEARANCE BETWEEN THE FRONT OF ALL OF YOUR TRAILERS AND THE TRUCK CAB.*

## WARNING

*DO NOT INVERT THE BALL IN THE SOCKET WHEN CARRYING HEAVY LOADS ON 2 WHEEL DRIVE TRUCKS. THE BALL MAY HIT THE TOP OF THE DIFFERENTIAL. REMOVE THE BALL FROM THE SOCKET BEFORE LOADING. A PLUG FOR THE SOCKET IS AVAILABLE FROM B & W.*

# INSTALLATION INSTRUCTIONS

**STEP ONE** - REMOVE SPARE TIRE TO EASE INSTALLATION.



**STEP TWO** - MARKING AND CUTTING 4 INCH HOLE IN TRUCK BED FLOOR

Begin by verifying and measuring the correct hole location in the truck bed floor. Measure from the back end (tailgate end) of the truck bed floor by hooking a tape measure over the back of the truck box and mark the floor at the correct measurement. Next, center the location between the wheel wells. This will be the center point for the 4-inch hole. This location is critical to the correct installation of this hitch, so measure, mark and saw carefully. If the truck has a plastic bed liner, you may drill through both, but it is more difficult to accurately locate the midpoint between the fender wheel wells, and to be sure that the bed liner does not move while sawing the hole. Make a 4-inch hole at this location using a 4-inch hole saw, or by marking a 4-inch circle and cutting it out with a saber saw equipped with a metal cutting blade.

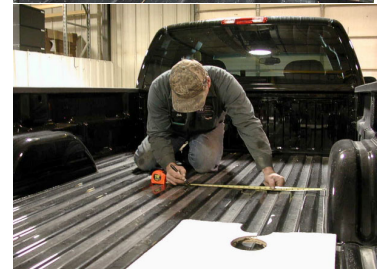

**4" HOLE LOCATION**  
**8' LONG BED AND SHORT BED**  
**(BED LESS THAN 8 LONG') - 45 1/8"**

**TIP:** B&W uses a 3/4" piece of plywood as a drilling guide to prevent the hole saw from moving while drilling the 4" hole in the truck bed.

### STEP THREE - CROSS MEMBER INSTALLATION

Select the rear crossmember that is notched on one side. With the long (**2 1/2"**) side of the angle iron pointing down and the short (**2"**) side with the notches facing the rear of the truck, position it across the top of the frame rails, between the bed and frame, by pushing it through the opening in the wheel well on the driver's side of the truck. Make certain that the notches fit tightly against the **truck bed** crossmember on the back of the truck. Select the second crossmember without notches and place it between the bed and frame, by pushing it through the opening in the wheel well on the driver's side of the truck. With the two crossmembers approximately parallel, position them about **9"** apart, spaced in front and behind the hole in the truck bed floor and hanging over the same distance on each side of the frame rails.

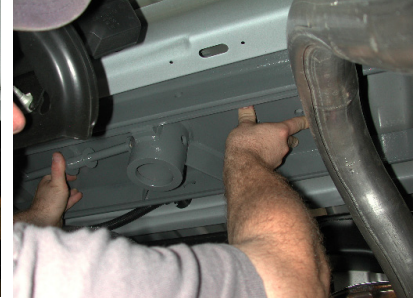

### STEP FOUR

With the latch pin mechanism on the driver's side of the truck, raise the center section of the hitch into position between the crossmembers from beneath the truck. The round tube hitch receiver that protrudes from the center section must fit through the hole in the truck bed floor. Fasten the center section to the crossmembers using seven of the 1/2" x 1 1/2" bolts. Start these bolts through the holes in the crossmember and place a flat washer, a lock washer and nut on each bolt **DO NOT fully tighten at this time.**

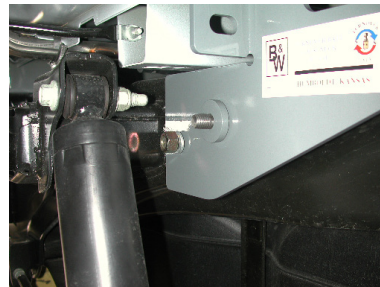
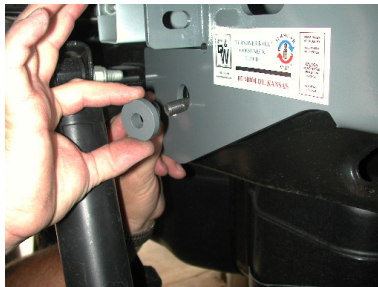
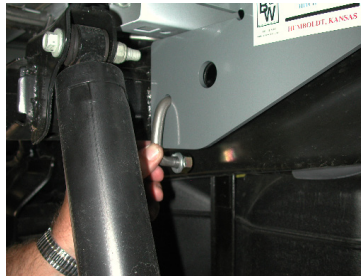

### STEP FIVE- INSTALL SIDEPLATES

Vehicle equipment with a NO-CAP fuel neck have a drain/vent hose attached to the frame on the driver side in the area where the rear shock mounts to the frame. This hose must be detached from the frame and relocate before installing the sideplate for the drivers side.

Install the sideplates by placing the top back hole over the stud on the rear cross member with a flat washer, lock washer, and nut, then bolt the front flange of the sideplate to the front cross member with a bolt, flat washer, lock washer, and nut **DO NOT fully tighten at this time.** The two holes at the front of the sideplates should align with two holes in the frame behind the shock and shock mount. Next place a flat washer, lock washer, and nut on one end of the 2" u-bolt. (see fig. 1) Place the other end into the smaller hole at the front of the sideplate and twist through the frame until the threaded end is protruding out the other hole of the sideplate (as shown in pictures above). Next place the sideplate insert over this end, being sure that the straight edge of the insert lines up with the straight edge of the hole of the sideplate and is pushed into the frame all the way. (The insert will not set flush against the sideplate when tightened if it is not properly aligned.) Then place a lock washer and nut on the u-bolt and tighten both ends of the u-bolt to 45 ft. lbs. Repeat for other side. Next tighten the seven center section bolts to 90 ft. lbs. Then tighten the two bolts that fasten the sideplates to the cross members on each side to 90 ft. lbs.

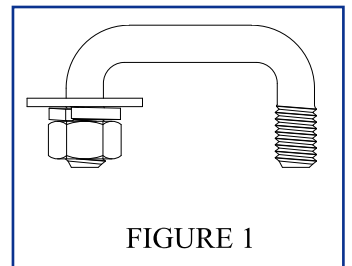
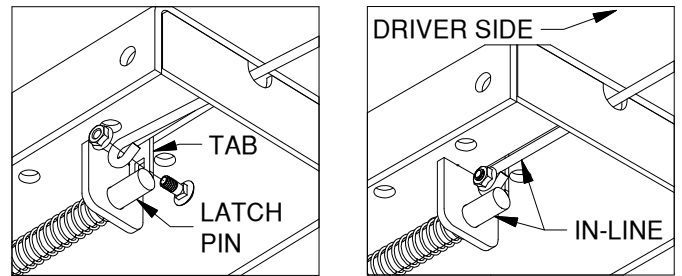

FIGURE 1

## **STEP SIX – INSTALL LATCH PIN RELEASE HANDLE**

WARNING: LATCH PIN WILL NOT FUNCTION PROPERLY IF HANDLE IS NOT INSTALLED CORRECTLY. Install the latch pin release handle by inserting it through the slot in the end of the center section on the driver's side of the truck. Align the handle eyelet with the square hole in the latch pin so the handle is in line with the latch pin as shown. Secure the handle to the pin with the 5/16 X 3/4" carriage bolt and 5/16" locking flange nut as shown. Note: The included 5/16" cap screw can replace the carriage bolt if wrench access on the "cab side" of the handle is limited. Tighten the nut until it is secure. Do not over-tighten and deform the handle eyelet.



## **STEP SEVEN - INSTALL SAFETY CHAIN BRACKETS**

To install the safety chain brackets it is necessary to drill four 1/2" holes through the truck bed floor. Drill the holes from beneath the truck, through the two holes located on each side **and furthest away from the round receiver tube in the center section.** This will locate the safety chain brackets in the lowest point of the floor corrugation. Drop a U-bolt through each pair of holes from the topside of the truck bed floor. Place a spring and lock nut on each of the four legs. Tighten the lock nuts until 1/4" of thread extends through the lock nut.

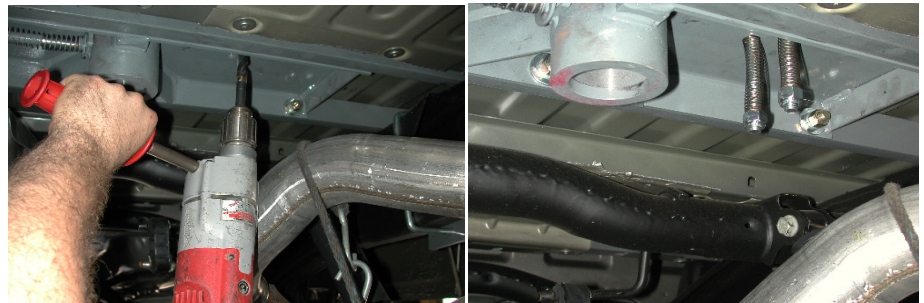

## **STEP EIGHT - ENGAGE LATCH PIN**

Retract the latch pin by pulling the handle all the way out until it stops and then rotating it clockwise. Place the 2-5/16" ball in the hitch receiver. Engage the latch pin by rotating the handle counter clockwise. Be certain the latch pin passes through the holes in the 2-5/16" ball and fully engages through the hitch receiver. Finally, remove and lightly grease the four corners on the square base of the 2-5/16" ball.