

<THESE INSTRUCTIONS MUST BE GIVEN TO THE END USER>



B&W Trailer Hitches

1216 Hawaii Rd / PO Box 186
Humboldt, KS 66748
P:800.248.6564
F:620.869.9031

See Limited Lifetime Warranty at
bwtrailerhitches.com/warranty

Call or Email us for
Installation Support
hitches@turnoverball.com
bwtrailerhitches.com

16K Heavy Duty Receiver Hitch Installation Instructions

MODEL HDRH25503

2014-2019 RAM 2500 & 3500
Long Bed Trucks with Factory Bumper

PARTS LIST		
ITEM	DESCRIPTION	QTY
1	Side Plate Driver	1
2	Side Plate Passenger	1
3	Hitch Center Section	1
4	Spacer 3/16" X 1-1/4" X 1-1/2"	6
5	Spacer 3/16" X 1" X 1-1/2"	4
6	Locking Strap 1/4" X 1-3/8" X 3"	2
7	Locking Strap 1/4" X 2" X 2"	2
8	1/2" X 2" Carriage Bolt	4
9	1/2" X 1-1/2" Cap Screw	10
10	1/2" Lock Washer	14
11	1/2" Finish Nut	14
12	1/2" X 20" Fish Wire	2

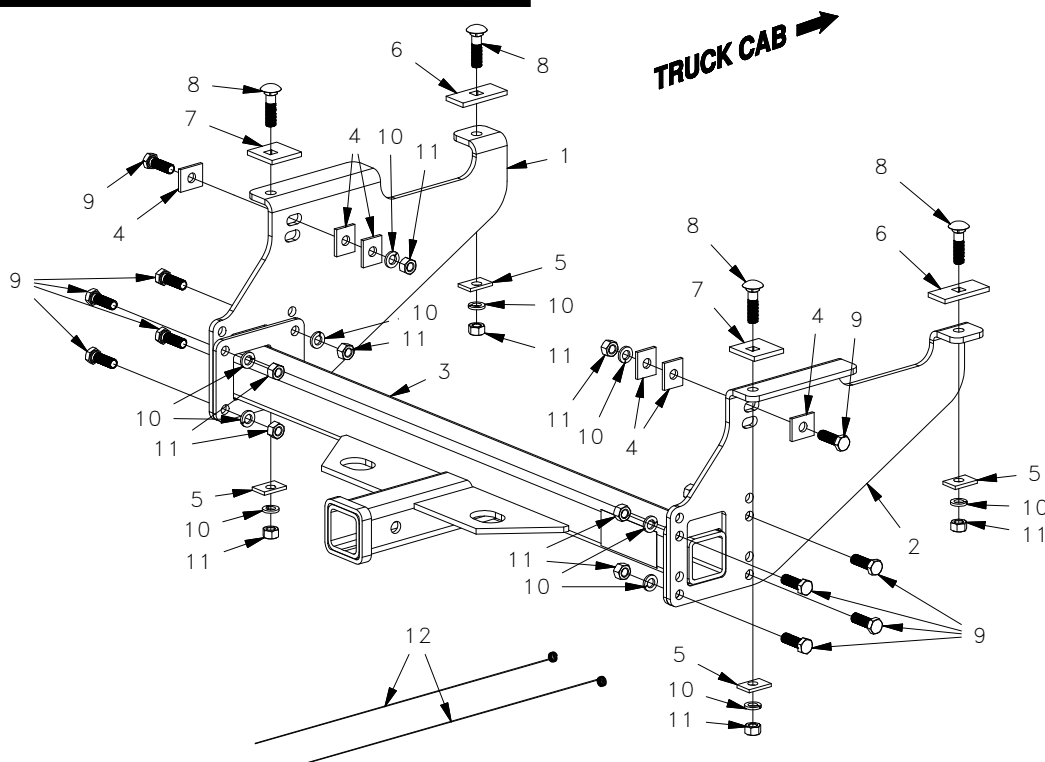

⚠️ WARNING

Failure to comply with the safety information in these instructions could result in serious injury or death.

- ⚠️ Read all installation and operating instructions along with all labels before using this product.
- ⚠️ Adding components to the chassis of any vehicle can be hazardous. There is potential for unexpected combustion of fuel, electric shock, burns, shifting or falling of unstable vehicle, damage to vehicle, injury from tool usage and many other hazards. This installation must be completed by someone who is aware of the hazards involved. This person must be knowledgeable of proper safety procedures for a vehicle modification of this nature, and for usage of the equipment required to perform the installation.
- ⚠️ Without proper knowledge, towing can be a dangerous activity. Understand all the risks involved with towing before proceeding. For information on towing safety, see "**The Trailer Handbook: A Guide to Understanding Trailer and Towing Safety**" from the National Association of Trailer Manufacturers, www.NATM.com and your trailer manufacturer's owner's manual.
- ⚠️ Do not exceed tow or tongue rating of coupler, tow or tongue rating of hitch, or tow or weight ratings of truck or trailer. See vehicle and trailer manufacturer information for ratings. Exceeding these ratings may cause damage to towing components or loss of attachment between the trailer and truck.
- ⚠️ Additional caution must be used when towing a wedge car trailer. Towing stability greatly depends on keeping the center of gravity as low as possible. Load heavy cars over the axles. Never tow with a single car on the front of the trailer. When towing a wedge car trailer, never exceed speeds that are reasonable for the roadway conditions (e.g. turns, going around a curve, etc.). Failure to account for proper trailer center of gravity and speeds that are reasonable for the roadway conditions may cause damage to the truck, trailer, towing components, and loss of attachment between the truck and trailer.
- ⚠️ This product was designed to fit vehicles in their original, "as manufactured" condition. Compatibility with vehicles having replacement parts, or other modifications is not guaranteed. Inspect vehicle for modifications before installation of this product.
- ⚠️ Always use safety chains while towing. Crossing the safety chains under the tongue of trailer may prevent some damage to the trailer if detachment occurs.
- ⚠️ Do not modify this product in any manner. Doing so could alter its integrity and lead to a loss of attachment between the trailer and the tow vehicle.
- ⚠️ Periodically inspect hitch, making sure that all fasteners are tightly secured.

PREPARING TO INSTALL

NOTE: Remove all parts from the packaging and familiarize yourself with all the parts and tools required. Use the parts list on the front page to verify that all parts and hardware are present.

1. Installation requires several common tools and a few specialized tools. Below is a listing of equipment used during a typical installation.

TOOLS REQUIRED

- Impact wrench or ratchet with 3/4" sockets
 - 3/4" Box end wrench
 - Flat head screwdriver (optional)
 - Eye & Ear protection
 - Torque wrench capable of tightening to 80 ft-lbs
2. Remove spare tire to provide easier access to the frame, some truck models will require the removal of the spare tire for installation.
 3. This receiver hitch may require slight modification to, or relocation of, vehicle systems or components so that the hitch may be installed in the proper location. It is very important to make sure that you have the correct hitch for your application before any modifications to the vehicle are made.
 4. The side plates of this hitch must mount against the bottom of the frame. Any brackets or accessories not critical to the structure of the vehicle that are mounted to the bottom of the frame in the installation area may need to be removed. See the steps on positioning and mounting the hitch for the hitch location to see if there will be any interference.
 5. The side plates of this hitch have holes for attachment of wire harness components. If possible, familiarize yourself with the location of wiring components and routing before beginning installation.

ASSEMBLE HITCH

1. **Installation configuration.** This hitch is designed to fit two different vehicle applications:
 - For pickups with a factory receiver hitch, the center section should be bolted to the side plates in the bottom set of holes and oriented so the receiver tube is under the cross tube, see Figure A1.
 - For pickups without a factory receiver hitch or with the factory recover tube cut off of the round frame/ bumper support, the center section should be bolted to the side plates in the top set of holes and oriented so the receiver tube is on top of the cross tube, see Figure A2.
2. **Assemble the hitch.** Using the required orientation, attach the side plates using eight 1/2" x 1-1/2" cap screws, lock washers and nuts, as shown in Figure A3. Attach the side plates so that the "ears" of the side plates are toward the outside. Do not fully tighten hardware at this time.

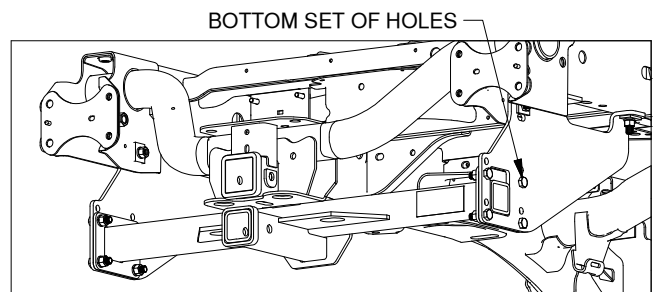

Figure A1: View of truck with factory receiver hitch. (Bumper not shown)

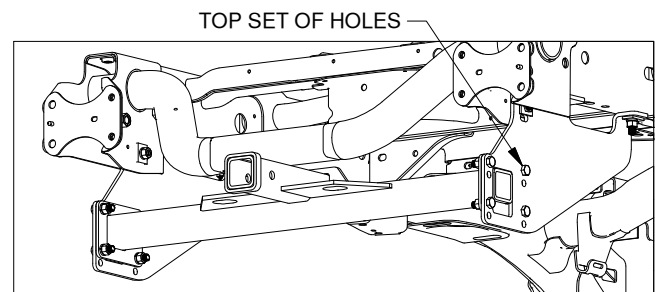

Figure A2: View of truck without factory receiver hitch. (Bumper not shown)

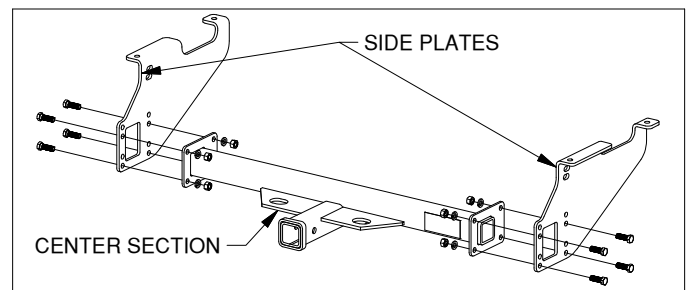

Figure A3: Center section and side plate assembly.

INSTALL FRAME HARDWARE

- 1. Locate the two hardware mounting locations.** On each side of the frame towards the rear of the truck there are two mounting hole locations, see Figure B1. Each hole will need a locking strap and carriage bolt.
- 2. Install the forward mounting location.** Locate the fish wires, 1/4" X 1-3/8" X 3" Locking Straps and two 1/2" X 2" carriage bolts. Thread a Carriage Bolt onto the coil end of the fish wire, see Figure B2. Next, position the locking strap into the hole, half-in/half-out, in the side of the frame as shown in Figure B3. Then pass the straight end of the fish wire through the locking strap and the hole in the side of the frame. Angle the fish wire so that the wire then passes through the forward mounting location in the bottom of the truck frame, see Figure B3. Continue to pass the fish wire through the frame until both the locking strap and the carriage bolt are inside the frame. Pull the threads of the carriage bolt through the locking strap and out of the frame. Make sure that the square shoulder of the carriage bolt is fully engaged in the square hole of the locking strap. Uncoil the fish wire and repeat this process on the other side.
- 3. Install the rear mounting location.** Locate the 1/4" X 2" X 2" locking straps and two 1/2" X 2" Carriage Bolts. Place the locking strap inside of the frame so that its square hole can be seen through the rear frame mounting locations. See Figure B4. Pass a fish wire, coil end first, up through the now visible hole in the locking strap, then pass the coil up and out of the frame, see figure B5. Thread a Carriage Bolt onto the coil end of the fish wire. Pull the fish wire and bolt back through the frame until the carriage bolt has passed through the locking strap. Make sure that the square shoulder of the carriage bolt is fully engaged in the square hole of the locking strap. Uncoil the fish wire and repeat this process for the other side.

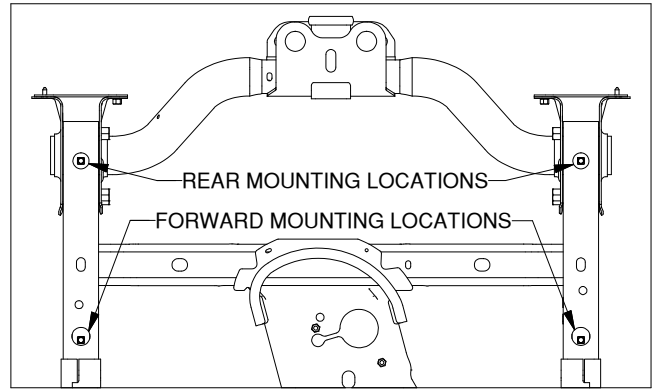

Figure B1: View under truck bed looking up.

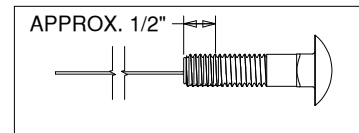

Figure B2: Fish wire diagram.

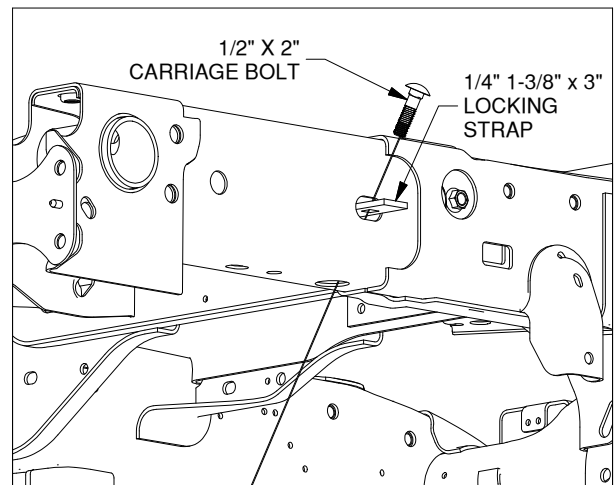

Figure B3: View looking at passenger side of frame.

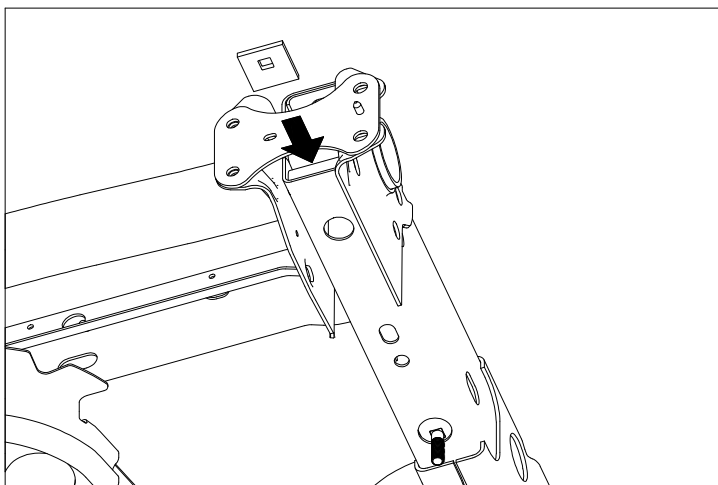

Figure B4: View of passenger side of frame.

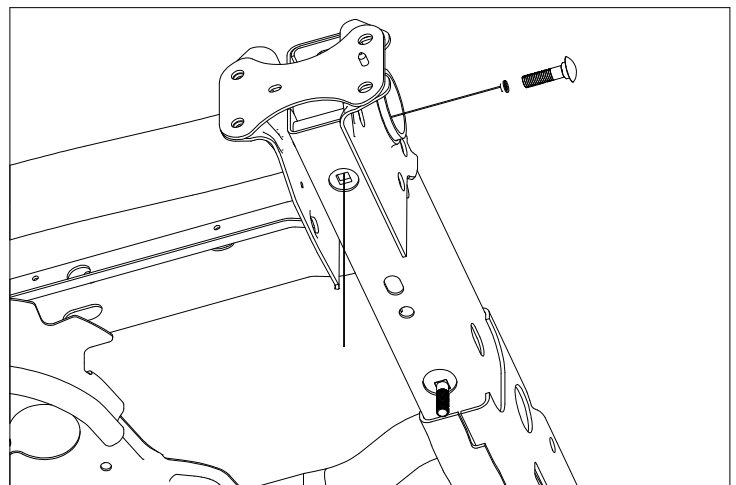

Figure B5: View of passenger side of frame.

MOUNT THE HITCH

1. **Position the hitch.** Place the hitch under the frame and lift until the holes in the ears of the side plates are over the bolts installed in the frame. Secure these connections with 3/16" X 1" X 1-1/2" spacers, lock washers, and finish nuts as shown in Figure C1. Hand tighten the hardware at this time.

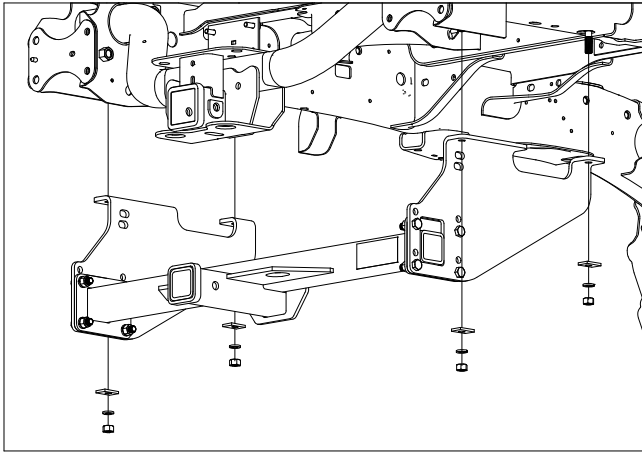

Figure C1: View looking at passenger side of frame looking towards the cab. (Bumper and bed not shown)

2. **Secure sideplates:** Attach the side plates to the frame cross member brackets with 1/2" X 1-1/2" long cap screws, 3/16" X 1-1/4" X 1-1/2" spacers, lock washers and finish nuts as shown in Figure C2. If needed install a spacer in between the side plate and the frame cross member bracket.

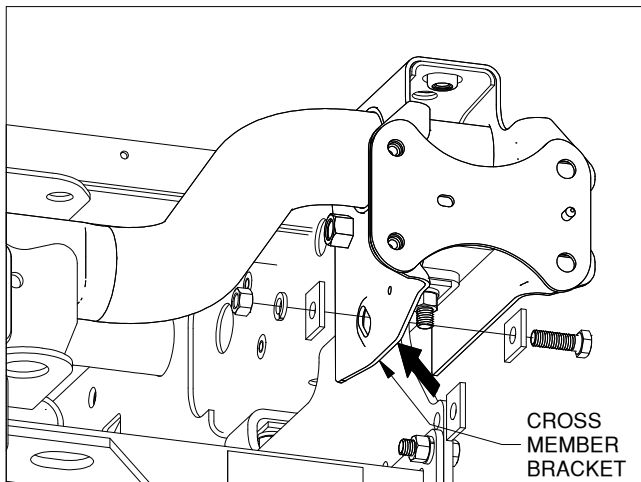

Figure C2: View looking at passenger side of frame looking towards the cab. (Bumper and bed not shown)

TIGHTEN HARDWARE

Tighten the hardware on the connections between the frame and the side plates to 80 foot pounds. Next make sure that the edges of the side plate mounting brackets on the center section match up with the rearward edges of the side plates and tighten these connections. Torque these bolts to 80 foot pounds as well.

SECURE WIRING

Secure all wiring so that it will not be damaged while using the vehicle. Any loose wiring may be secured with wire ties or similar tie down devices.